

2M HD IP Fixed Mini Bullet Camera

User's Manual_Install Part G Ver. 1.3 / 2021.03

Before installing and using the camera, please read this manual carefully.
Be sure to keep it handy for future reference.

Contents

INTRODUCTION

- 03 Important Safety Information
- 06 Product & Accessories
- 07 Part Name

INSTALLATION

- 08 Installation
- 09 Cabling

SPECIFICATION

- 10 Dimension

Safety Instruction

These instructions are intended to ensure that the user can use the product correctly to avoid danger or property loss. If the product is not functioning properly or damaged, contact the service center or purchasing office.

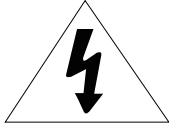

Warnings

Serious injury or death may be caused if any of these warnings are neglected.



Cautions

Injury or equipment damage may be caused if any of these cautions are neglected.



POWER

1. Use only standardized adapters written in the manual. Incorrect connection of the power source can cause fire, electric shock, or failure.
2. If there is smoke or a strange smell from the power source, disconnect the power immediately and contact the service center or purchasing office. If you continue to use it as it is, it can cause fire and electric shock.
3. Disconnect the power plug from the outlet before connecting to the power terminal block.



INSTALLATION

1. Install it according to the temperature and humidity environment suitable for the product specifications. Otherwise, it can cause fire and electric shock.
2. Thunder and lightning can cause problems with the camera. When installing, be careful to minimize damage caused by lightning such as grounding.
3. Do not place conductive materials (drivers, coins, metal sticks, etc.) and water-filled containers on the camera. It causes injuries caused by fire, electric shock, and falling.
4. If you want to move the installed product, turn off the power and move it or reinstall it. Otherwise, it can cause fire and electric shock.
5. Do not install it in places where there is a lot of moisture, dust, soot, etc. It causes fire and electric shock.
6. Avoid places where direct sunlight comes in or where heat comes out, such as heating appliances. It causes fire and electric shock.



CLEANING

1. Do not spray water directly on each part of the product when cleaning. It causes fire and electric shock.



POWER

1. Use the power line after fixing it firmly to the power connection terminal. Incomplete connection can cause a fire.
2. Do not extend the adapter output cable. If you need to install the power cable extension, please contact the service center.
3. Use insulated power for PoE connected external power.



INSTALLATION

1. It is recommended not to touch the lens when installing the product as the factory ships with a focus adjustment completed during the manufacturing completion inspection phase.
2. Avoid installing cameras facing bright lights like sunlight. Causes damage to the image sensor.
3. Make sure it safe and securely when installing camera on the wall or ceiling. This can cause injury by the fall.
4. Do not connect multiple cameras to one adapter. Excess capacity causes abnormal heat and fire.
5. Wear protective gloves when installing/uninstalling the camera. This causes burns caused by high temperature on the surface of the product.
6. Don't drop or shock the product. Please stay away from places where vibration is severe or magnet types are present.
7. Install it in a well-ventilated place. This can cause fire and failure.



CLEANING

1. Wipe the contaminated surface with a clean, soft, dry cloth or wet the soft, dry cloth to prevent water from flowing, then wipe the contaminated area.

Installation and Use Precautions

1. The battery (battery pack or equipped battery) must not be exposed to excessive heat such as sunlight, fire, etc.
2. Do not disassemble the camera at your discretion.
3. If you forcefully install the product with excessive force, malfunction can damage the camera.
4. Do not punch or shake the camera and be careful not to damage the camera with careless storage or malfunction.
5. Be careful not to install the camera in a rainy or humid place, and do not leave it in a wet place.
6. Installing or using the product in water can cause serious product failure.
7. Do not install the product if there is chemical or vapor in the place where the product is installed, or if it can be generated.
8. Be careful not to get chemicals on the surface of the product when installing the product. Chemical solvents such as cleaning agents and adhesive components can cause fatal damage to the surface of the product.
9. Do not install it near the kitchen or cooking table as edible oil such as soybean oil can also cause product damage and deformation. It can cause product damage.
10. Be careful not to get foreign substances on the Micro SD card terminal. If there is any foreign substance, wipe it with a soft cloth.
11. Data will not be saved at the end of the life of the Micro SD card. In this case, purchase a new Micro SD card.
12. Moisture may occur in the glass of the camera when the new product box is opened (or when the product is initially running). The generated moisture is removed by a Gore vent attached to the camera within hours of the power connection.
13. For products enclosed with a desiccant or card-type absorbent, please install it according to the manual.
14. Use only with cart, stand, tripod, bracket, or table specified by the manufacturer, or sold with the apparatus.
15. Unplug this apparatus when a cart is used. Use caution when moving the cart/apparatus combination to avoid injury from tip-over.



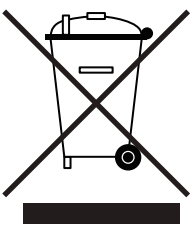

Disposal of Old Appliances

1. The symbol marked in the product, will follow and covered by the Europe Directive 2002/95/EC.
2. All electronic disposal of waste is different by the government or locally, so so it need to check.
3. The correct disposal of your old appliance will help prevent potential negative consequences for the environment and human health.
4. For more detailed information about disposal of your old appliance, please contact your city office, waste disposal service or the shop where you purchased the product.



This equipment has been tested and found to comply with the limits for a Class A digital device, pursuant to part 15 of the FCC Rules. These limits are designed to provide reasonable protection against harmful interference when the equipment is operated in a commercial environment. This equipment generates, uses, and can radiate radio frequency energy and, if not installed and used in accordance with the instruction manual, may cause harmful interference to radio communications. Operation of this equipment in a residential area is likely to cause harmful interference in which case the user will be required to correct the interference at his own expense.

Introduction - Product & Accessories

⊠ Please check if all the camera and accessories are included in the package.

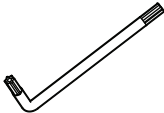
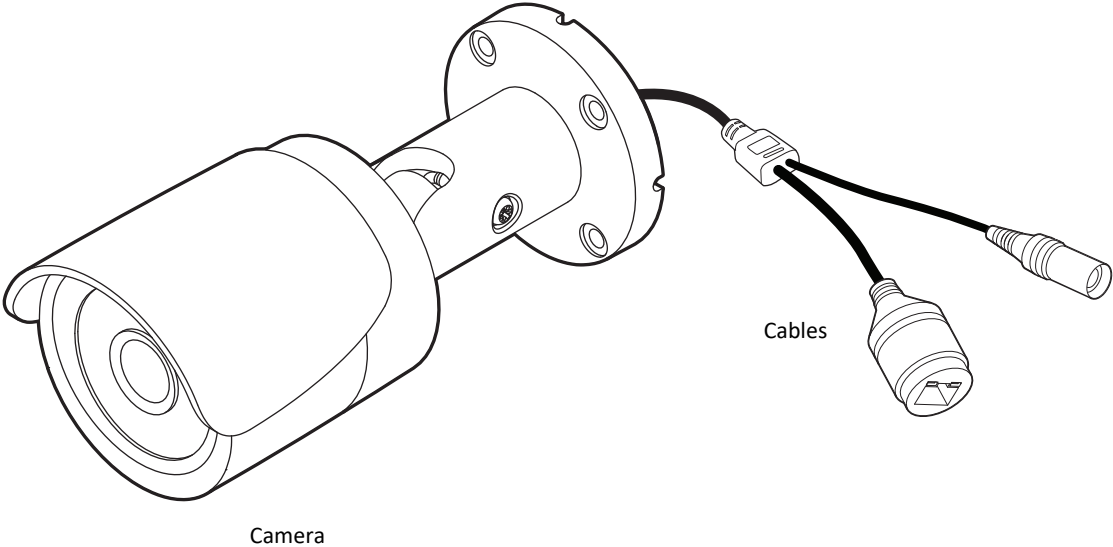

Torx Wrench

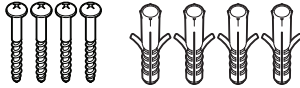

Screw & Plastic Anchor-4pcs



Quick Manual

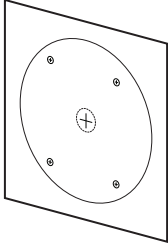

Template Sheet

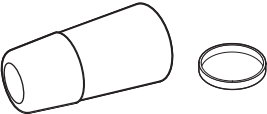

Waterproof cap & Gasket

Introduction - Part Name

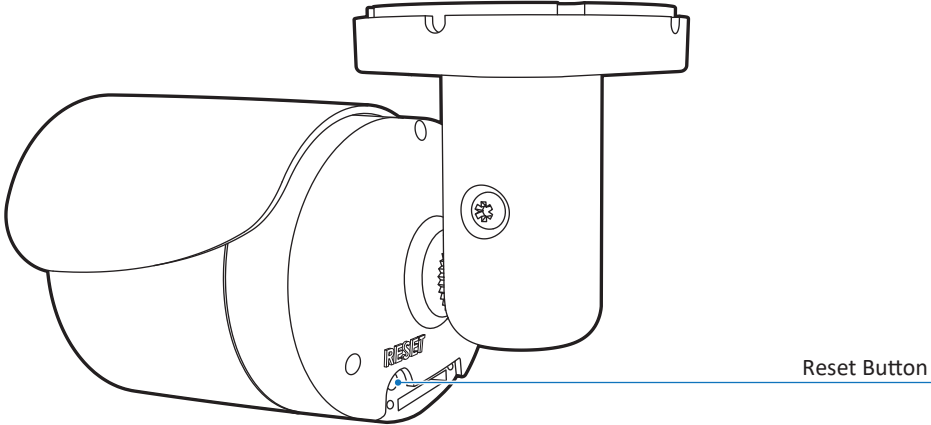
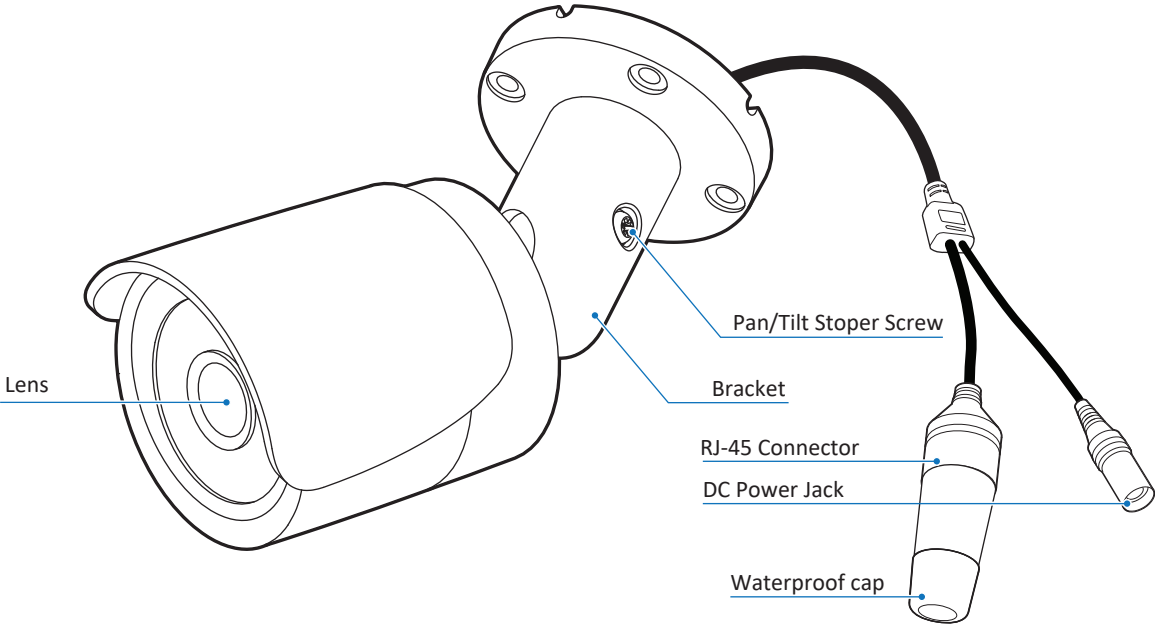

Installation - Installation

Before installing your camera, you have to read the following cautions.

1. You have to check whether the location can bear five times of the weight of your camera.
2. Don't let the cable to be caught in improper place or the electric line cover to be damaged. Otherwise it may cause a breakdown or fire.
3. When installing your camera, don't allow any person to approach the installation site. If you have any valuable things under the place, move them away.

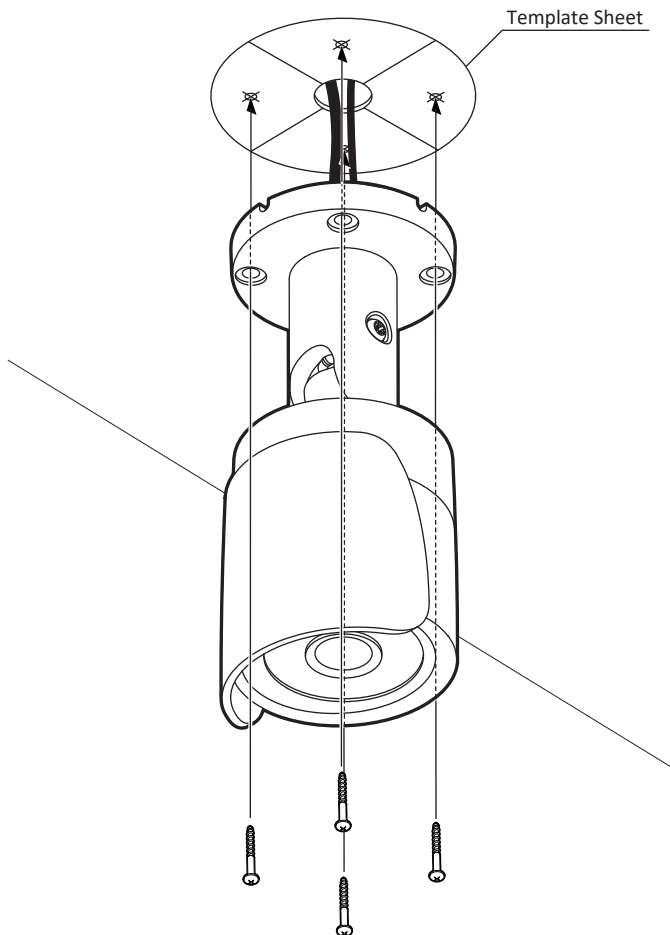

- 1 To pass cables through the wall/ceiling, drill holes on the wall/ceiling.
- 2 Connect the network cable, power cable respectively. See the section 'Installation - Cabling' for details.
 - ⊠ Put the Lan cable into (a), then (b) will be assembled to (a) tightly. As a final step, (c) need to be assembled to (b) without making any space.

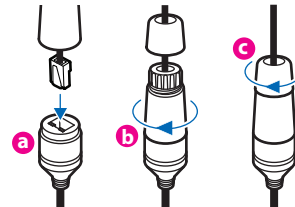

- 3 Fix the camera on the wall/ceiling by screw provided.
 - ⊠ Loosen the Pan/Tilt stopper screw a little before fixing the camera.
- 4 After adjusting the view angle, tighten the Pan/Tilt stopper screw.

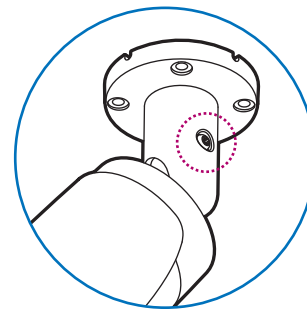

- ⊠ **Reset to the Factory Defaults**
Press the reset button for 5 seconds to return the setup to the Factory Default.

- ⊠ **Warning:**
If you press the 'Reset' button, you will lose all setting data. If needed, please, make a note for further installation.

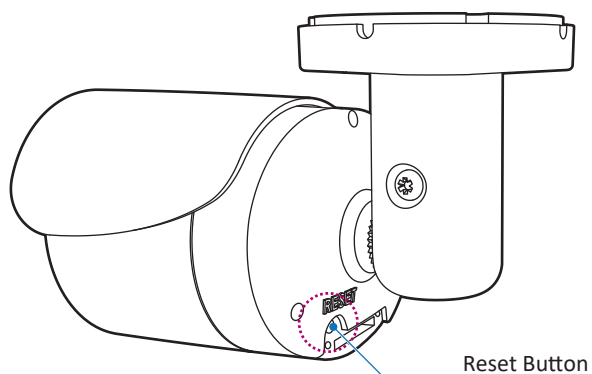

Installation - Cabling

Two Options

Use a PoE-enabled switch to connect data and power through a single cable and begin viewing and recording images instantly. A non-PoE switch will require an adaptor for power transmission.

1. Using a PoE-Enabled Switch

The Camera is PoE-compliant, allowing transmission of power and data via a single Ethernet cable. PoE eliminates the need for the different cables used to power, record, or control the camera. Follow the illustration below to connect the camera to a PoE-enabled switch using an Ethernet cable.

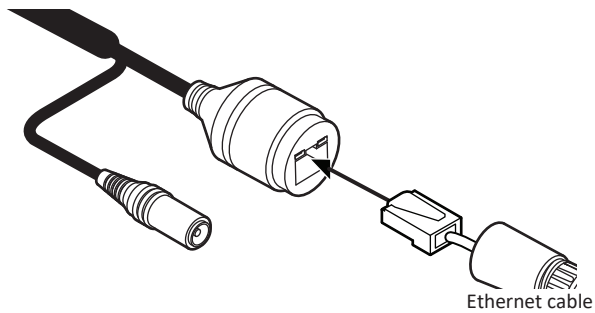

2. Using a Non-PoE Switch

If a PoE-enabled switch is not used, use a power adaptor for power transmission and non-PoE switch for data transmission.

Follow the illustrations below to connect the camera without a PoE-enabled Switch.

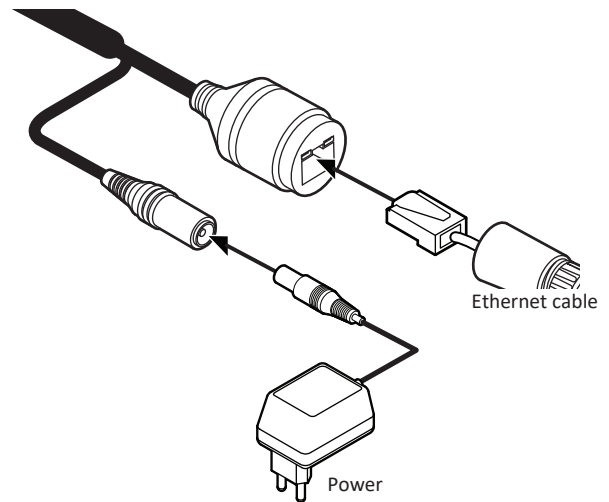

Specifications - Dimension

Unit: mm

